

# ***VEX1000 Wiring diagram***

***Danfoss ECL Comfort 310 automatic***

***Danfoss ECL Comfort 310 automatik***

***Système de régulation Danfoss ECL Comfort 310***

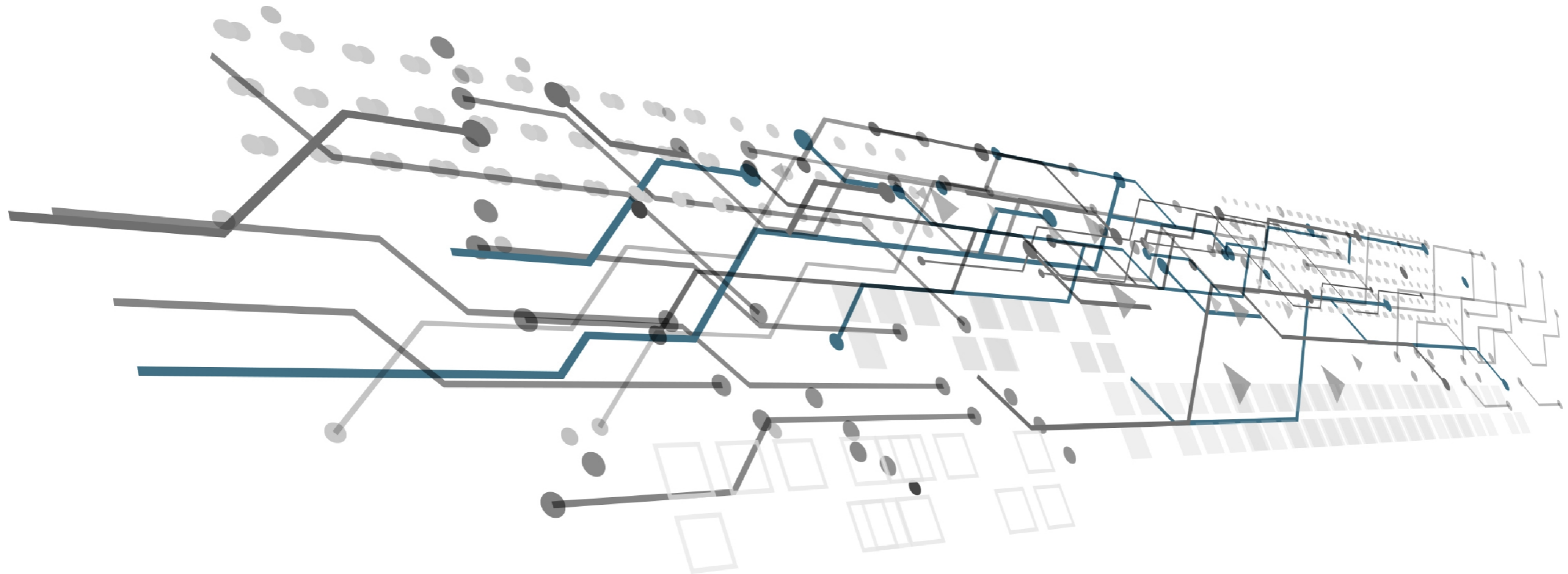

# VEX1000 - Danfoss ECL (3x400V)

2029220

EXHAUSTO	Revision:	Project:	Start date:	04-02-2026	Constructor:	DKTSA	Page:	1
	A	VEX1000 - Danfoss ECL (3x400V)	Revision date:	26-02-2026	Approved by:	DKLEG	Previous page:	0
	Drawing number:	Page Title:	Replaces:	-	Scale:	1:1	Next page:	2
	2029220	Project information	EC no.:	-	Format:	A3	Pages in total:	32

Page	Title	(GB)	Titel	(DE)	Titre	(FR)	Last edit
1	Project information		Projektinformationen		Informations sur le projet		26-02-2026
3	Standards		Standard		Normes		05-02-2026
4	Standards		Standard		Normes		12-02-2026
5	Component overview		Komponentenübersicht		Vue d'ensemble des composants		17-02-2026
9	Principles for all configuration options		Prinzipien für alle Konfigurationsoptionen		Principes pour toutes les options de configuration		11-02-2026
10	Basic control panel 3x400V		Basis-Schaltschrank 3x400V		Armoire de commande de base 3x400V		26-02-2026
11	Control panel terminals		Klemmen des Schaltschranks		Bornes du tableau de commande		26-02-2026
20	Main current		Hauptstrom		Courant principal		26-02-2026
21	Pilot current		Steuerstrom		Courant pilote		26-02-2026
22	Standard - Modbus connections		Standard – Modbus-Anschlüsse		Standard – Raccordements pour modbus		26-02-2026
23	Standard - Fan & Rotor/Bypass controls		Standard – Ventilator- und Rotor-/Bypass-Steuerungen		Standard – Commandes by-pass / du ventilateur et du rotor		11-02-2026
24	Standard - Dampers		Standard – Register		Standard - Volets		11-02-2026
25	Options - HW/CW controls		Optionen – HW/CW-Regler		Options – Commandes HW/CW		26-02-2026
26	Options - Customer connections		Optionen – Kundenseitige Anschlüsse		Options - Raccordements du client		24-02-2026
40	Standard - Dual PTH 1		Standard – Doppel-PTH 1		Standard – Double PTH 1		11-02-2026
41	Standard - Dual PTH 2		Standard – Doppel-PTH 2		Standard – Double PTH 2		11-02-2026
50	Smoke detector for rooms		Rauchmelder für Räume		Détecteur de fumée pour installation en pièce		20-02-2026
51	Smoke detector for duct mounting		Rauchmelder zur Kanalmontage		Détecteur de fumée pour montage en conduit		24-02-2026
52	Fire thermostat 40-70°		Brandschutzthermostat 40-70°		Thermostat incendie 40-70°		24-02-2026
53	PIR motion detector		PIR-Bewegungssensor		Capteur de mouvement PIR		26-02-2026
54	Timer button with LED indicator		Timer-Taste mit LED-Anzeige		Bouton minuterie avec indicateur LED		26-02-2026
55	PTH-6202 Constant Pressure regulation kit		PTH-6202 Konstantdruckregelung-Set		Kit de régulation de pression constante PTH-6202		24-02-2026

<b>EXHAUSTO</b>	Revision:	Project:	Start date:	04-02-2026	Constructor:	DKTSA	Page:	2
	<b>A</b>	<b>VEX1000 - Danfoss ECL (3x400V)</b>	Revision date:	26-02-2026	Approved by:	DKLEG	Previous page:	1
	Drawing number:	Page Title:	Replaces:	-	Scale:	1:1	Next page:	3
	<b>2029220</b>	<b>Table of Contents</b>	EC no.:	-	Format:	A3	Pages in total:	32

**Identification of wires by colour (according to EN 60204-1)**

<u>Main current:</u>	<u>Hauptstrom:</u>	<u>Courant principal:</u>	<u>400/230VAC</u>
Phase:	Phase:	Phase :	BK
Neutral:	Neutral:	Neutre :	BK
Earth:	Erde:	Terre :	GNYE
<u>Pilot current:</u>	<u>Steuerstrom:</u>	<u>Courant pilote:</u>	<u>230/24VAC</u>
Phase:	Phase:	Phase :	RD
Neutral:	Neutral:	Neutre :	RD
Earth:	Erde:	Terre :	GNYE
<u>Pilot current:</u>	<u>Steuerstrom:</u>	<u>Courant pilote:</u>	<u>24VDC</u>
<u>Positive (+):</u>	<u>Positiv (+):</u>	<u>Positif (+) :</u>	<u>BU</u>
<u>Negative (-):</u>	<u>Negativ (-):</u>	<u>Négatif (-) :</u>	<u>BU</u>
<u>Unknown potential:</u>	<u>Unbekanntes Potenzial:</u>	<u>Potentiel inconnu:</u>	
All:	Alle:	Tout:	OG

**Abbreviations of colours (according to IEC 60757)**

Black	Schwarz	Noir	BK
Brown	Braun	Marron	BN
Red	Rot	Rouge	RD
Orange	Orange	Orange	OG
Yellow	Gelb	Jaune	YE
Green	Grün	Vert	GN
Blue	Blau	Bleu	BU
Light Blue	Hellblau	Bleu clair	BU
Violet	Violett	Violet	VT
Gray	Grau	Gris	GY
White	Weiß	Blanc	WH
Pink	Rosa	Rose	PK
Green/Yellow	Grün/Gelb	Vert/Jaune	GNYE
Light-	Hell-	-clair	LT-

**Labelling of cables and cores (according to IEC 62491)**

Method CL

Method	Description
0	No labelling
A	Use of designated cables or cores
R	Identification labelling by means of reference designation (including cable number)
CL	Local-end connection labelling
CR	Remote-end connection labelling
CB	Both-end connection labelling
S	Signal labelling

Methode	Beschreibung
0	Keine Kennzeichnung
A	Verwendung vorgesehener Kabel oder Adern
R	Identifikationskennzeichnung mittels Referenzbezeichnung (inkl. Kabelnummer)
CL	Kennzeichnung der lokalen Verbindung
CR	Kennzeichnung der Remote-End-Verbindung
CB	Beidseitige Anschlussbeschriftung
S	Signalbeschriftung

Méthode	Description
0	Pas d'étiquetage
A	Utilisation de câbles ou per fil dédiés
R	Marquage d'identification au moyen d'une désignation de référence
CL	Étiquetage des connexions locales
CR	Étiquetage des connexions distantes
CB	Étiquetage des connexions aux deux extrémités
S	Étiquetage des signaux

EXHAUSTO

Revision:	A	Project: <b>VEX1000 - Danfoss ECL (3x400V)</b>	Start date:	04-02-2026	Constructor:	DKTSA	Page:	3				
			Revision date:	26-02-2026	Approved by:	DKLEG	Previous page:	2				
			Drawing number:	2029220	Page Title:	Standards	Replaces:	-	Scale:	1:1	Next page:	4
			EC no.:		-		Format:	A3	Pages in total:	32		

Component	Location <span style="float: right;">(GB)</span>	Standort <span style="float: right;">(DE)</span>	Emplacement <span style="float: right;">(FR)</span>
+A0	Customer connections	Kundenanschlüsse	Raccordements du client
+A1	Control Panel	Schaltschrank	Tableau de commande
+A2	Cable connections to AHU aggregate	Kabelverbindungen zum RLT-Lüftungsgerät	Raccordements de câbles à l'appareil CTA
+A3	AHU aggregate	RLT-Lüftungsgerät	Appareil CTA
+A4	Outside AHU aggregate	Außenseite des RLT-Lüftungsgeräts	À l'extérieur de l'appareil CTA

Component	Object	Examples	Objekt	Beispiele	Objet	Exemples
-B	Sensing	CO2 & temperature sensors	Sensorik	CO2- und Temperatursensoren	Détection	Sondes de CO2 et de température
-C	Storage	USB drives & application keys	Speicher	USB-Sticks und Anwendungsschlüssel	Stockage	Clés USB et clés d'application
-E	Emitting	Electric heaters	Emission	Elektrische Heizgeräte	Émetteur	Chauffages électriques
-F	Protecting	Miniature circuit-breaker	Schutz	Miniaturlistungsschalter	Protection	Disjoncteur à maximum miniature
-G	Generating	Circulation pumps	Erzeugung	Umwälzpumpen	Générateur	Pompes de circulation
-K	Information processing	AHU Controller	Informationsverarbeitung	RLT-Lüftungsgerätesteuerung	Traitement de l'information	Cerveau de l'appareil CTA
-M	Driving	Motors	Antrieb	Motoren	Entrainement	Moteurs
-Q	Controlling	Supply disconnecting device	Steuerung	Versorgungstrennvorrichtung	Commande	Dispositif de déconnexion de l'alimentation
-R	Restricting	Valves & dampers	Drosselung	Ventile und Register	Limitation	Vannes et volets
-S	Human interaction	Touch panel	Menschliche Interaktion	Bedienfeld mit Touchscreen	Interaction humaine	Écran tactile
-T	Transforming	Power supply	Transformation	Stromversorgung	Transformation	Alimentation électrique
-U	Holding	Cabinet, wire-duct & DIN-rails	Halten	Schrank, Kabelkanal und DIN-Schienen	Maintien	Cabinet de ventilateur, gaine de câbles et rails DIN
-W	Guiding	Cables, wires & tubes	Führung	Kabel, Drähte und Rohre	Guidage	Câbles, fils & tubes
-X	Interfacing	Terminals & plugs	Schnittstellen	Klemmen und Stecker	Interface	Terminaux & bornes

(=)	Function	Funktion	Fonction
(+)	Location	Standort	Lieu
(-)	Product	Produkt	Produit
(.)	Sub name	Unterbezeichnung	Sous-titre

**Principles of structures and reference designations according to ISO/IEC RDS 81346**

**Grundlagen von Strukturen und Referenzbezeichnungen gemäß ISO/IEC RDS 81346**

**Principes de structures et désignations de référence selon ISO/IEC RDS 81346**

EXHAUSTO	Revision:	Project:	Start date:	04-02-2026	Constructor:	DKTSA	Page:	4
	A	VEX1000 - Danfoss ECL (3x400V)	Revision date:	26-02-2026	Approved by:	DKLEG	Previous page:	3
	Drawing number:	Page Title:	Replaces:	-	Scale:	1:1	Next page:	5
	2029220	Standards	EC no.:	-	Format:	A3	Pages in total:	32

Component	Function	(GB)	Funktion	(DE)	Fonction	(FR)
-0V	Terminals for 0VDC		Anschlüsse für 0 V DC		Bornes pour 0VDC	
-24V	Terminals for 24VDC		Anschlüsse für 24 V DC		Bornes pour 24VDC	
-B1.1	Extract air temperature		Außenlufttemperatur		Température de l'air extrait	
-B1.2	Exhaust air temperature		Fortlufttemperatur		Température de l'air rejeté	
-B2.1	Outdoor air temperature		Außenlufttemperatur		Température de l'air extérieur	
-B2.2	Heat recovery temperature		Wärmerückgewinnungstemperatur		Température de récupération de chaleur	
-B3	Heating return water temperature sensor		Temperatursensor Heizungsrücklaufwasser		Capteur thermique de l'eau de retour du chauffage	
-B4	CW return water temperature sensor		CW-Rücklauf-Temperatursensor		Capteur de température de retour eau froide	
-B7	Duct temperature sensor		Kanaltemperatursensor		Capteur de température de conduit	
-B8	CW supply water temperature sensor		CW-Vorlauf-Temperatursensor		Capteur thermique d'alimentation en CW	
-B10	HW supply water temperature sensor		HW-Vorlauf-Temperatursensor		Capteur de température de retour eau chaude	
-B11	Room temperature sensor		Raumtemperatursensor		Capteur de température ambiante	
-BP1	DualPTH 1		DualPTH 1		DualPTH 1	
-BP2	DualPTH 2		DualPTH 2		DualPTH 2	
-C1	ECL Application Key		ECL-Anwendungsschlüssel		Clé d'application ECL	
-E1	Cabinet heater		Schaltschrankheizung		Chauffage de l'armoire	
-F1	MCB for Exhaust air fan		Miniaturleistungsschalter für Fortluftventilator		MCB pour ventilateur de rejet extérieur	
-F2	MCB for Supply air fan		Miniaturleistungsschalter für Zuluftventilator		MCB pour ventilateur d'air soufflé	
-F3	MCB for rotor and power supply		Miniaturleistungsschalter für Rotor und Stromversorgung		Disjoncteur pour rotor et alimentation électrique	
-F4	MCB for Circulation pumps & ECL		Miniaturleistungsschalter für Umwälzpumpe & ECL		MCB pour pompe de circulation & ECL	
-K1	AHU Controller		Regler für RLT		Contrôleur CTA	
-M1.2	Exhaust air fan		Fortluftventilator		Ventilateur d'évacuation de l'air	
-M2.2	Supply air fan		Zuluftventilator		Ventilateur d'air soufflé	
-M3	Rotor		Rotor		Rotor	
-Q1	Supply disconnecting device		Versorgungstrennvorrichtung		Dispositif de coupure de l'alimentation	
-R1.2	Exhaust air damper		Fortluftregister		Volet d'air rejeté	
-R2.1	Outdoor air damper		Außenluftregister		Volet d'air extérieur	
-R3	Bypass damper		Bypassregister		Volet de dérivation	
-R5	Valve HW		Ventil HW		Vanne HW	

EXHAUSTO	Revision:	Project:	Start date:	04-02-2026	Constructor:	DKTSA	Page:	5
	<b>A</b>	<b>VEX1000 - Danfoss ECL (3x400V)</b>	Revision date:	26-02-2026	Approved by:	DKLEG	Previous page:	4
	Drawing number:	Page Title:	Replaces:	-	Scale:	1:1	Next page:	6
	<b>2029220</b>	<b>Component overview</b>	EC no.:	-	Format:	A3	Pages in total:	32



# Principles

EXHAUSTO	Revision:	Project:	Start date:	04-02-2026	Constructor:	DKTSA	Page:	Principles
	<b>A</b>	<b>VEX1000 - Danfoss ECL (3x400V)</b>	Revision date:	26-02-2026	Approved by:	DKLEG	Previous page:	6
	Drawing number:	Page Title:	Replaces:	-	Scale:	1:1	Next page:	9
	<b>2029220</b>	<b>Principles</b>	EC no.:	-	Format:	A3	Pages in total:	32

## COUNTER-FLOW

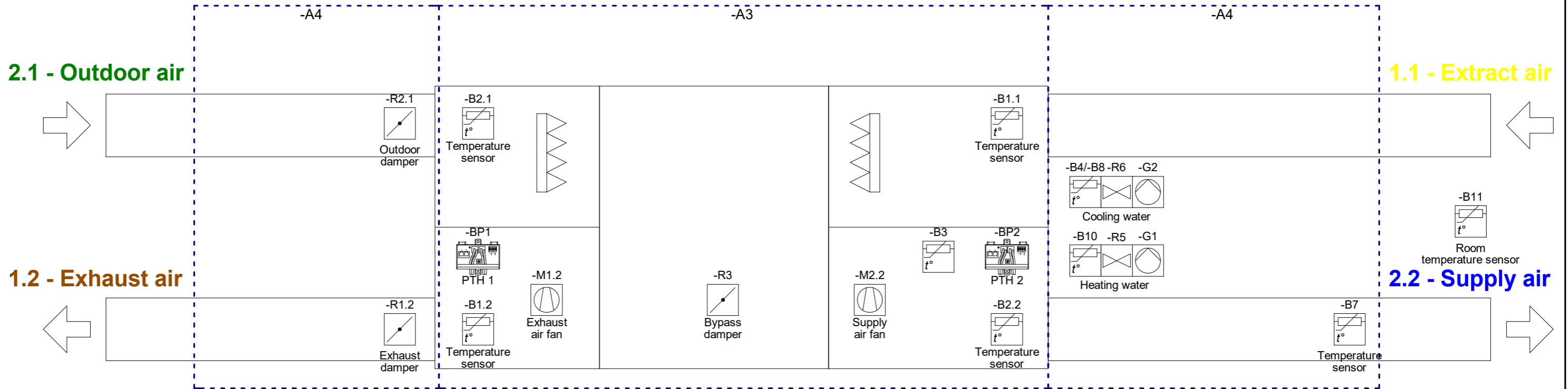

## ROTOR

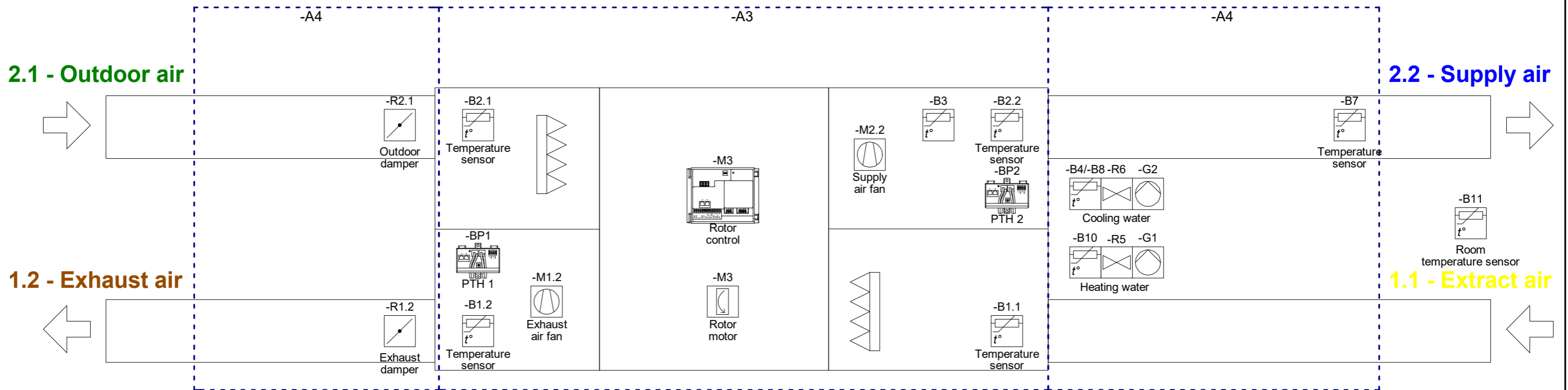

<b>EXHAUSTO</b>	Revision:	Project:	Start date:	04-02-2026	Constructor:	DKTSA	Page:	9
	<b>A</b>	<b>VEX1000 - Danfoss ECL (3x400V)</b>	Revision date:	26-02-2026	Approved by:	DKLEG	Previous page:	6
	Drawing number:	Page Title:	Replaces:	-	Scale:	1:5	Next page:	10
	<b>2029220</b>	<b>Principles for all configuration options</b>	EC no.:	-	Format:	A3	Pages in total:	32

# Arrangement drawings

EXHAUSTO	Revision:	Project:	Start date:	04-02-2026	Constructor:	DKTSA	Page:	Arrangement
	A	VEX1000 - Danfoss ECL (3x400V)	Revision date:	26-02-2026	Approved by:	DKLEG	Previous page:	9
	Drawing number:	Page Title:	Replaces:	-	Scale:	1:1	Next page:	10
	2029220	Arrangement drawings	EC no.:	-	Format:	A3	Pages in total:	32

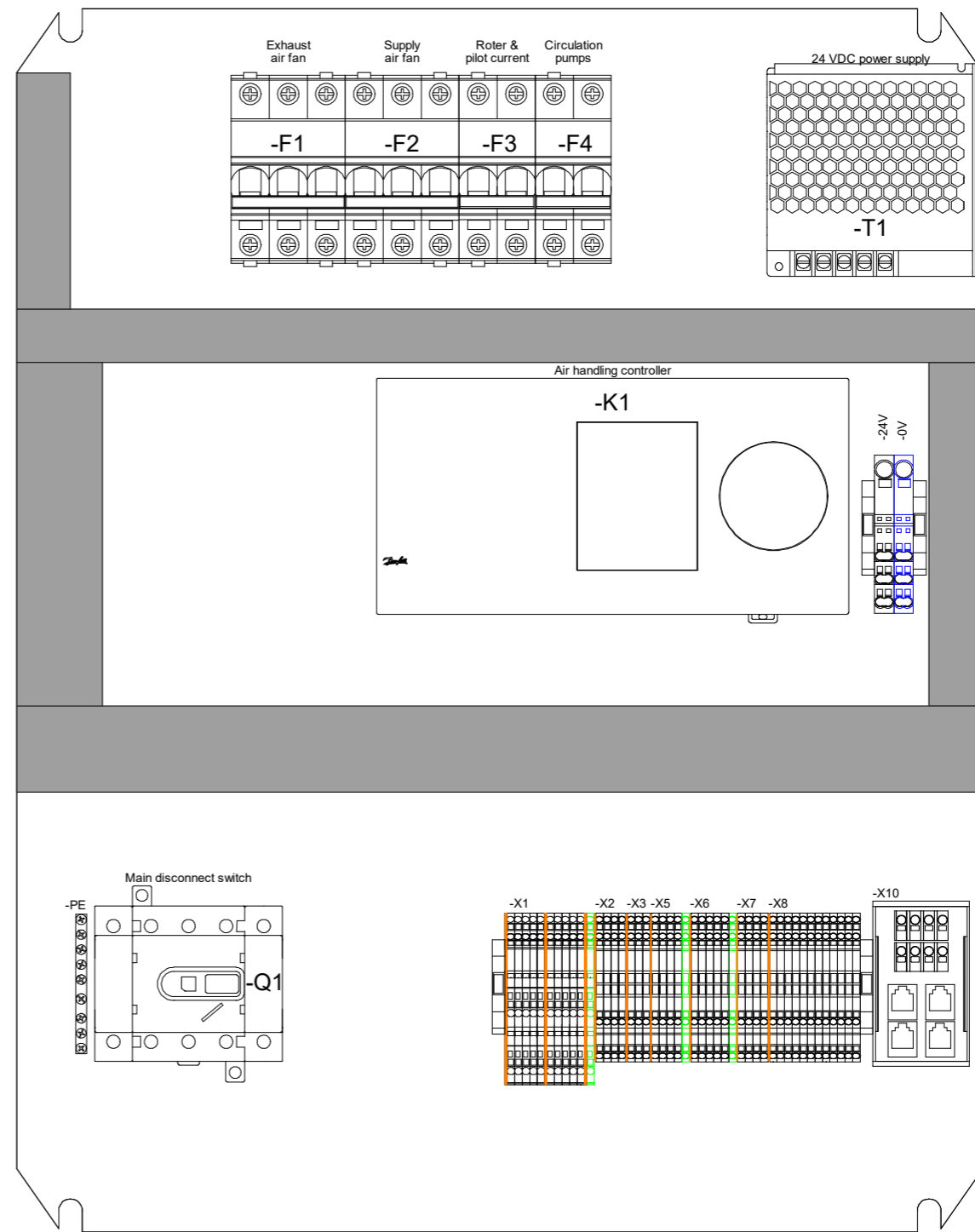
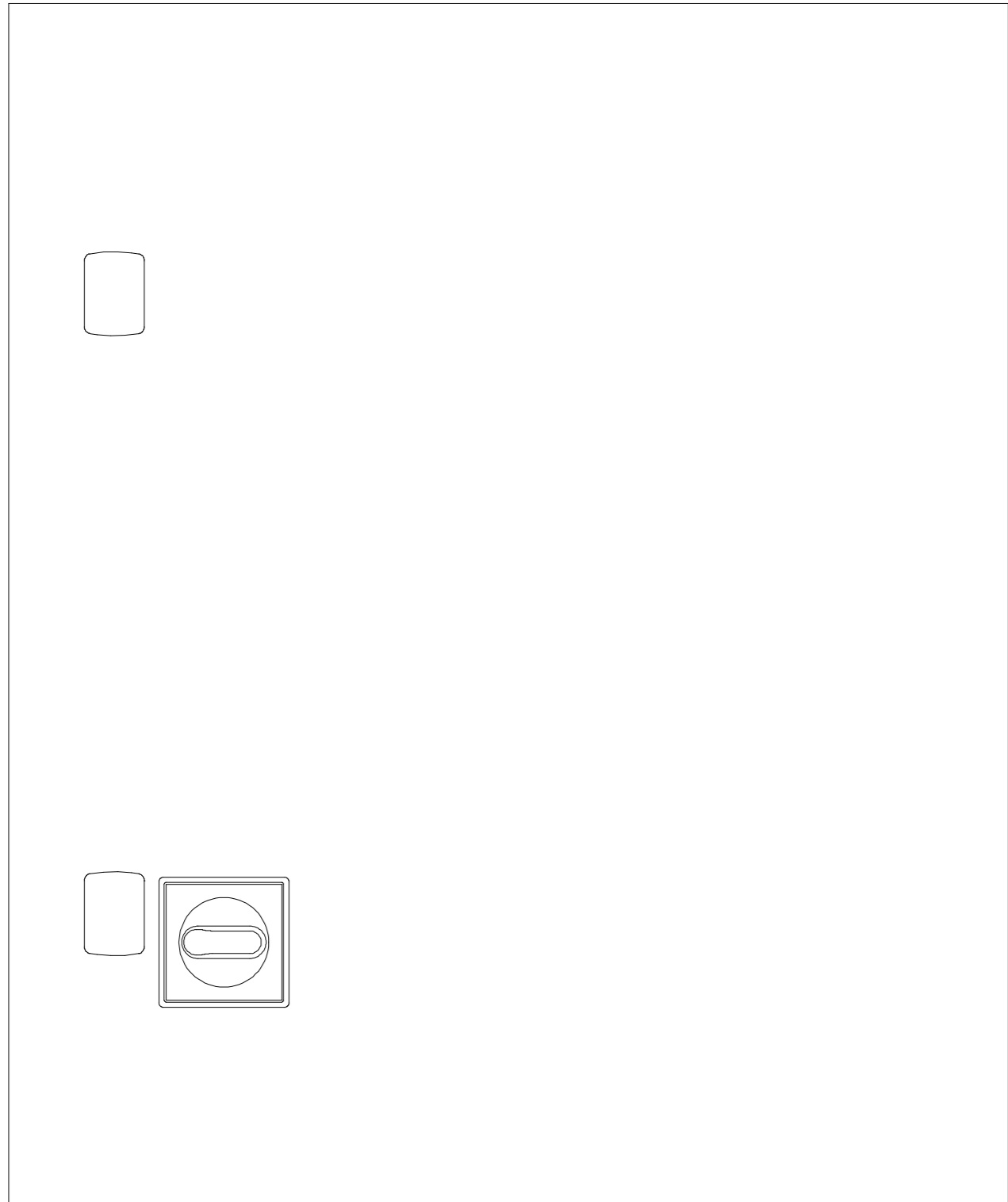

EXHAUSTO	Revision:	Project:	Start date:	04-02-2026	Constructor:	DKTSA	Page:	10
	<b>A</b>	<b>VEX1000 - Danfoss ECL (3x400V)</b>	Revision date:	26-02-2026	Approved by:	DKLEG	Previous page:	9
	Drawing number:	Page Title:	Replaces:	-	Scale:	1:3	Next page:	11
	<b>2029220</b>	<b>Basic control panel 3x400V</b>	EC no.:	-	Format:	A3	Pages in total:	32

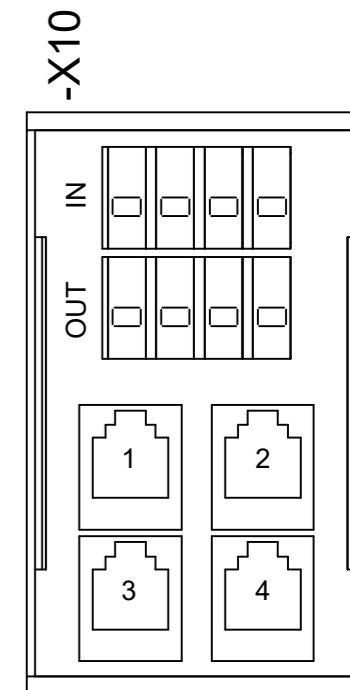
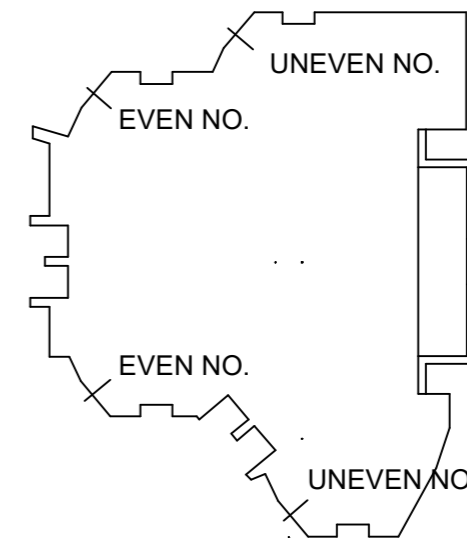
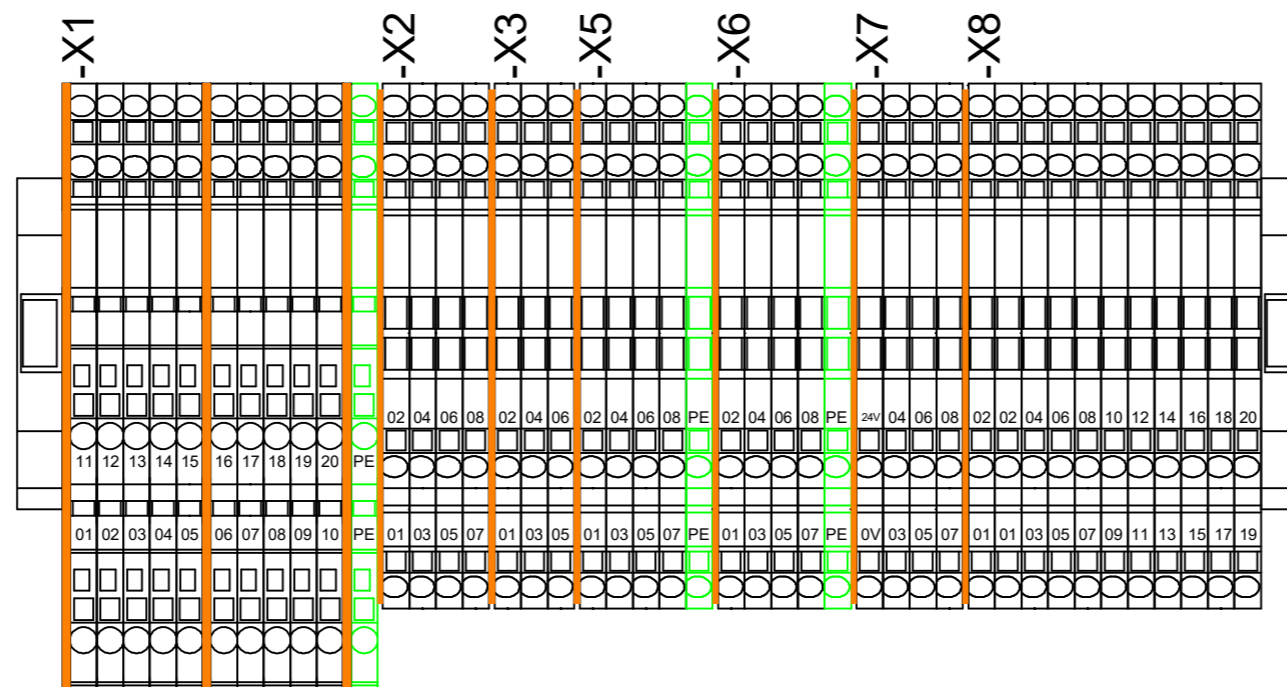

-X1:01 -M1.2 Exhaust air fan L1	-X2:01 - ECL-bus 1 S/GND	-X5:01 -R1 Valve HW 0V	-X7:01 - Not used with ECL controller
-X1:02 -M1.2 Exhaust air fan L2	-X2:03 - ECL-bus 1 +12V	-X5:02 -R1 Valve HW 24V	-X7:02 - Not used with ECL controller
-X1:03 -M1.2 Exhaust air fan L3	-X2:05 - ECL-bus 1 Bus B	-X5:03 -R1 Valve HW Signal	-X7:03 - Not used with ECL controller
-X1:04 -M2.2 Supply air fan L1	-X2:07 - ECL-bus 1 Bus A	-X5:04 -R1 Valve HW Not used	-X7:04 - Not used with ECL controller
-X1:05 -M2.2 Supply air fan L2	-X2:02 - ECL-bus 2 S/GND	-X5:05 -G1 HW circulation pump M	-X7:05 - Not used with ECL controller
-X1:06 -M2.2 Supply air fan L3	-X2:04 - ECL-bus 2 +12V	-X5:06 -G1 HW circulation pump Not used	-X7:06 - Not used with ECL controller
-X1:07 -M3 Rotor L	-X2:06 - ECL-bus 2 Bus B	-X5:07 -G1 HW circulation pump L	-X7:07 - Not used with ECL controller
-X1:08 -M3 Rotor N	-X2:08 - ECL-bus 2 Bus A	-X5:08 -G1 HW circulation pump N	-X7:08 - Not used with ECL controller
-X1:09 -MB Modbus 0V	-X3:01 - Not used with ECL controller	-X5:PE -G1 HW circulation pump PE	-X8:0V 24V power supply
-X1:10 -MB Modbus 24V	-X3:02 - Not used with ECL controller	-X6:01 -R2 Valve CW 0V	-X8:24V 24V power supply
-X1:11 -MB Modbus B-	-X3:03 - Not used with ECL controller	-X6:02 -R2 Valve CW 24V	-X8:01 - Fire alarm input
-X1:12 -MB Modbus A+	-X3:04 - Not used with ECL controller	-X6:03 -R2 Valve CW Signal	-X8:02 - Fire alarm input
-X1:13 - Not used with ECL controller	-X3:05 - Not used with ECL controller	-X6:04 -R2 Valve CW Not used	-X8:03 -B10 HW supply water temp.
-X1:14 - Not used with ECL controller	-X3:06 - Not used with ECL controller	-X6:05 -G2 CW circulation pump M	-X8:04 -B10 HW supply water temp.
-X1:15 - Not used with ECL controller		-X6:06 -G2 CW circulation pump Not used	-X8:05 -B11 Room temperature
-X1:16 - Not used with ECL controller		-X6:07 -G2 CW circulation pump L	-X8:06 -B11 Room temperature
-X1:17 - Not used with ECL controller		-X6:08 -G2 CW circulation pump N	-X8:07 -B7 Duct temperature
-X1:18 - Not used with ECL controller		-X6:PE -G2 CW circulation pump PE	-X8:08 -B7 Duct temperature
-X1:19 -B3 Temperature sensor -			-X8:09 -B8 CW supply watertemp.
-X1:20 -B3 Temperature sensor -			-X8:10 -B8 CW supply watertemp.
-X1:PE -PE Protective Earth PE			-X8:11 -B4 CW return watertemp.
			-X8:12 -B4 CW return watertemp.
			-X8:13 - A alarm output
			-X8:14 - A alarm output
			-X8:15 - Enable fire automation
			-X8:16 - Enable fire automation
			-X8:17 - Spare
			-X8:18 - Spare
			-X8:19 - Start signal
			-X8:20 - Start signal

EXHAUSTO	Revision: <b>A</b>	Project: <b>VEX1000 - Danfoss ECL (3x400V)</b>	Start date: 04-02-2026	Constructor: DK TSA	Page: 11
	Drawing number: <b>2029220</b>	Page Title: <b>Control panel terminals</b>	Revision date: 26-02-2026	Approved by: DK LEG	Previous page: 10
			Replaces: -	Scale: 1:1	Next page: 20
			EC no.: -	Format: A3	Pages in total: 32

# Circuit diagrams

EXHAUSTO	Revision:	Project:	Start date:	04-02-2026	Constructor:	DKTSA	Page:	Circuit diagrams
	<b>A</b>	<b>VEX1000 - Danfoss ECL (3x400V)</b>	Revision date:	26-02-2026	Approved by:	DKLEG	Previous page:	11
	Drawing number:	Page Title:	Replaces:	-	Scale:	1:1	Next page:	20
	<b>2029220</b>	<b>Circuit diagrams</b>	EC no.:	-	Format:	A3	Pages in total:	32

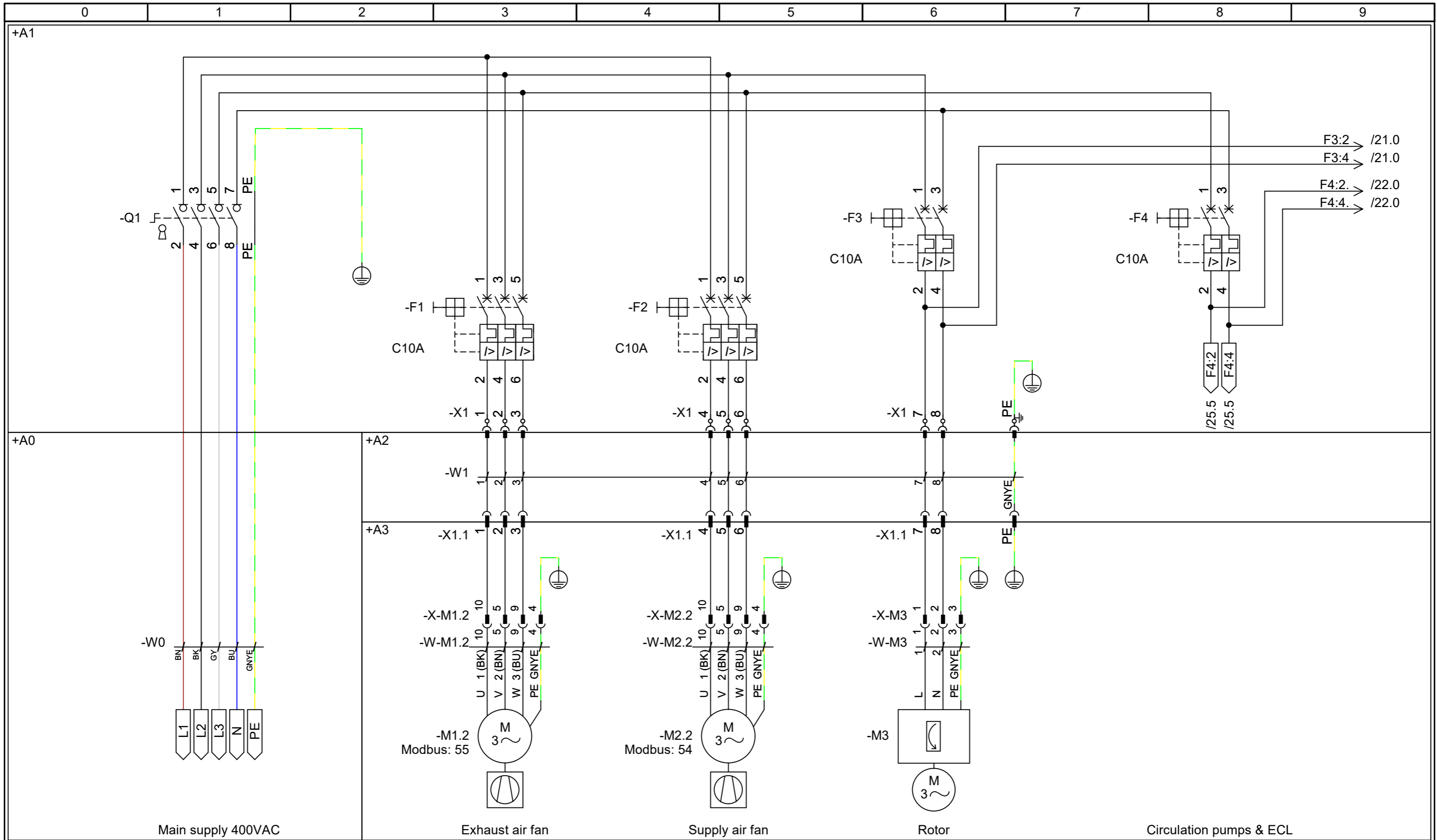

EXHAUSTO	Revision:	Project:	Start date:	04-02-2026	Constructor:	DKTSA	Page:	20
	<b>A</b>	<b>VEX1000 - Danfoss ECL (3x400V)</b>	Revision date:	26-02-2026	Approved by:	DKLEG	Previous page:	11
	Drawing number:	Page Title:	Replaces:	-	Scale:	1:1	Next page:	21
	<b>2029220</b>	<b>Main current</b>	EC no.:	-	Format:	A3	Pages in total:	32

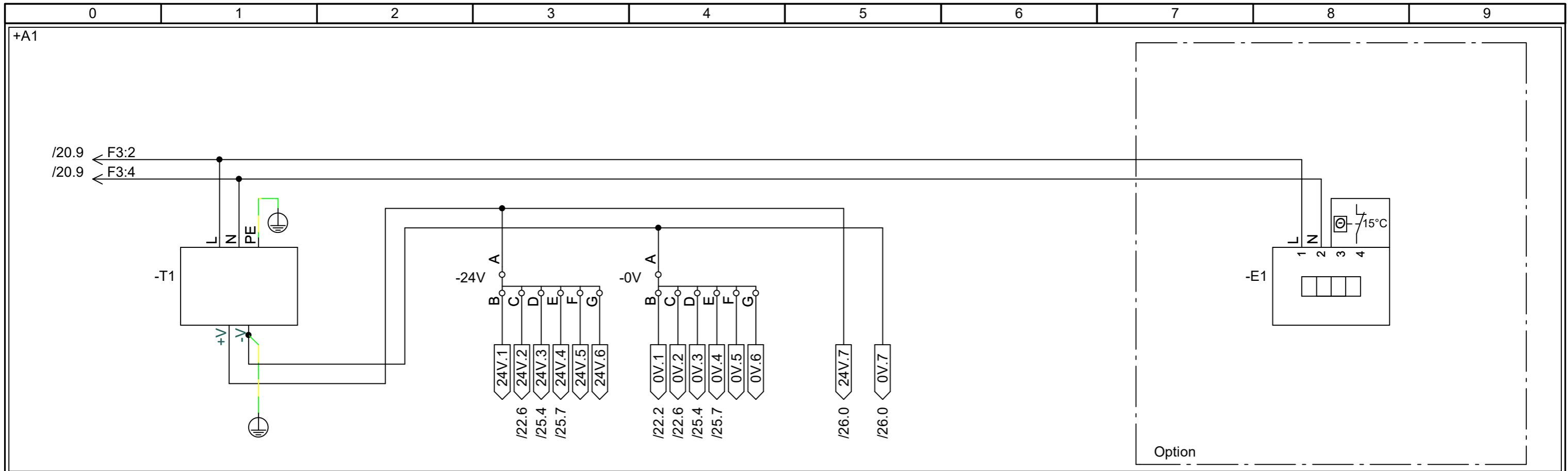

24VDC supply

Control panel heater

EXHAUSTO	Revision:	Project:	Start date:	04-02-2026	Constructor:	DKTSA	Page:	21
	A	VEX1000 - Danfoss ECL (3x400V)	Revision date:	26-02-2026	Approved by:	DKLEG	Previous page:	20
	Drawing number:	Page Title:	Replaces:	-	Scale:	1:1	Next page:	22
	2029220	Pilot current	EC no.:	-	Format:	A3	Pages in total:	32

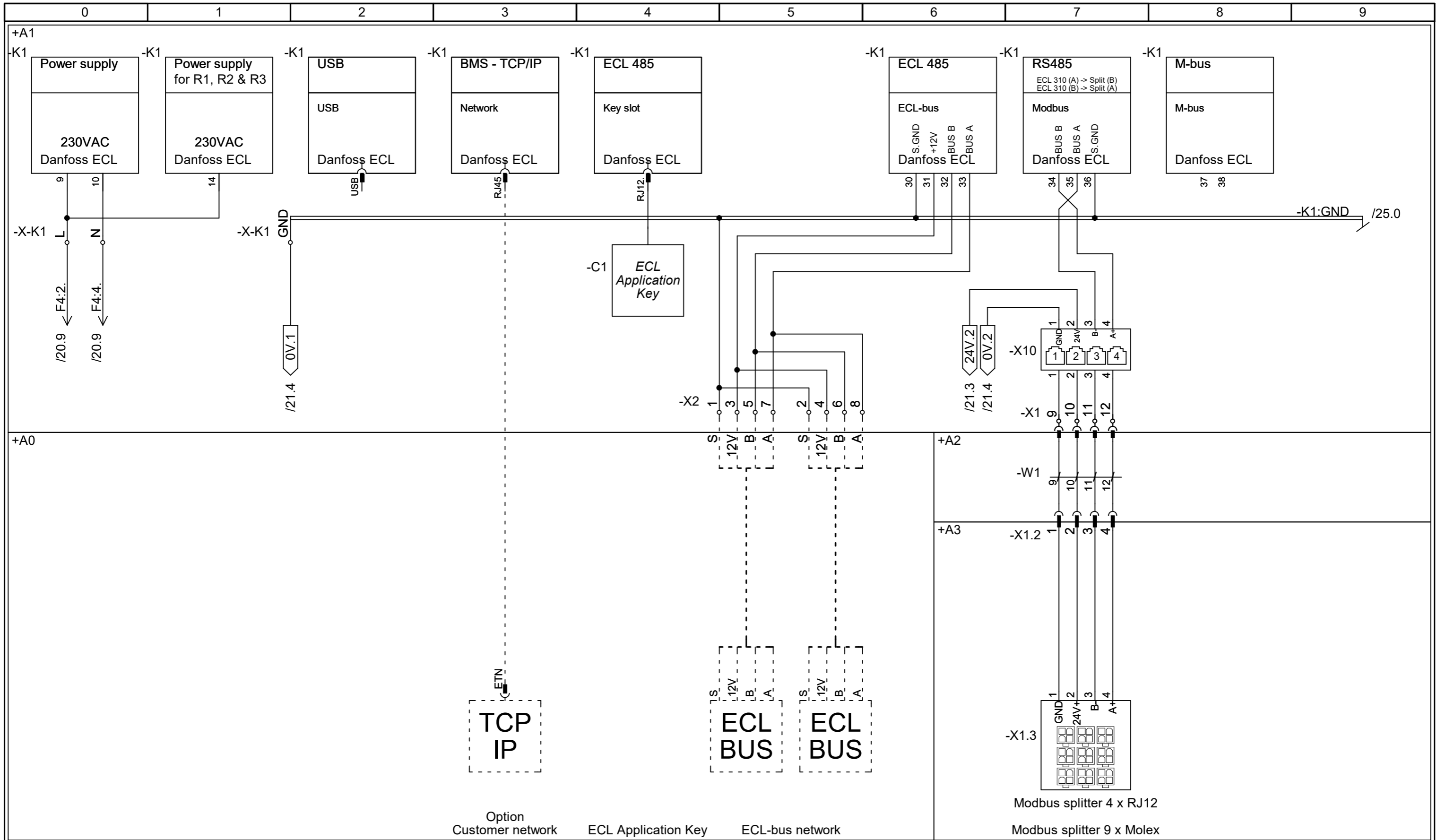

EXHAUSTO	Revision:	Project:	Start date:	04-02-2026	Constructor:	DKTSA	Page:	22
	<b>A</b>	<b>VEX1000 - Danfoss ECL (3x400V)</b>	Revision date:	26-02-2026	Approved by:	DKLEG	Previous page:	21
	Drawing number:	Page Title:	Replaces:	-	Scale:	1:1	Next page:	23
	<b>2029220</b>	<b>Standard - Modbus connections</b>	EC no.:	-	Format:	A3	Pages in total:	32

+A1

Rotor drive option

Counter-flow option

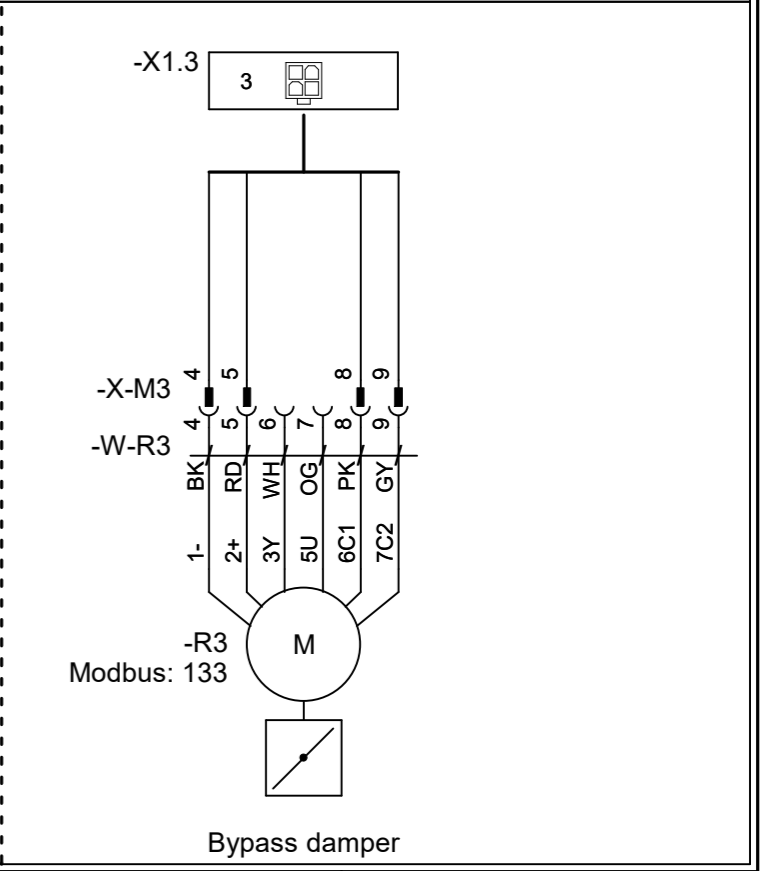
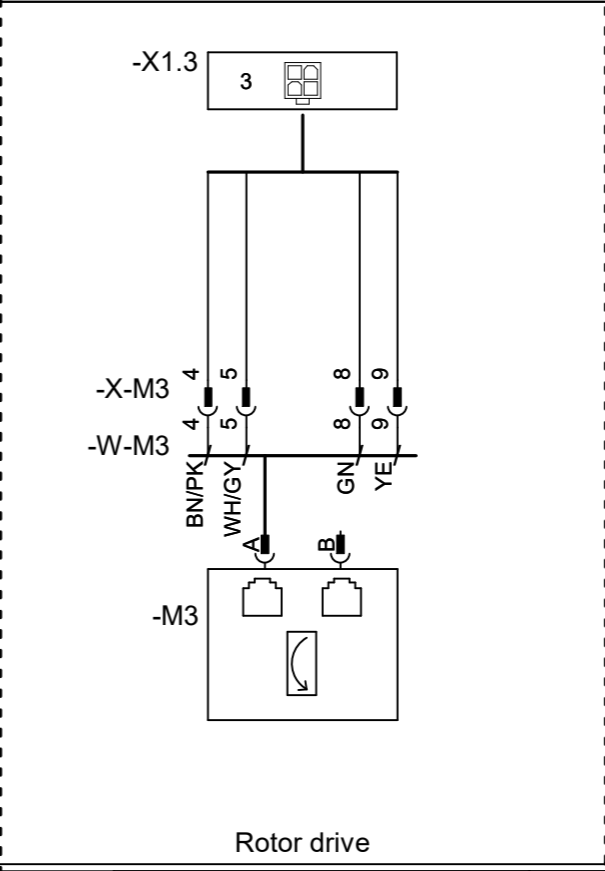
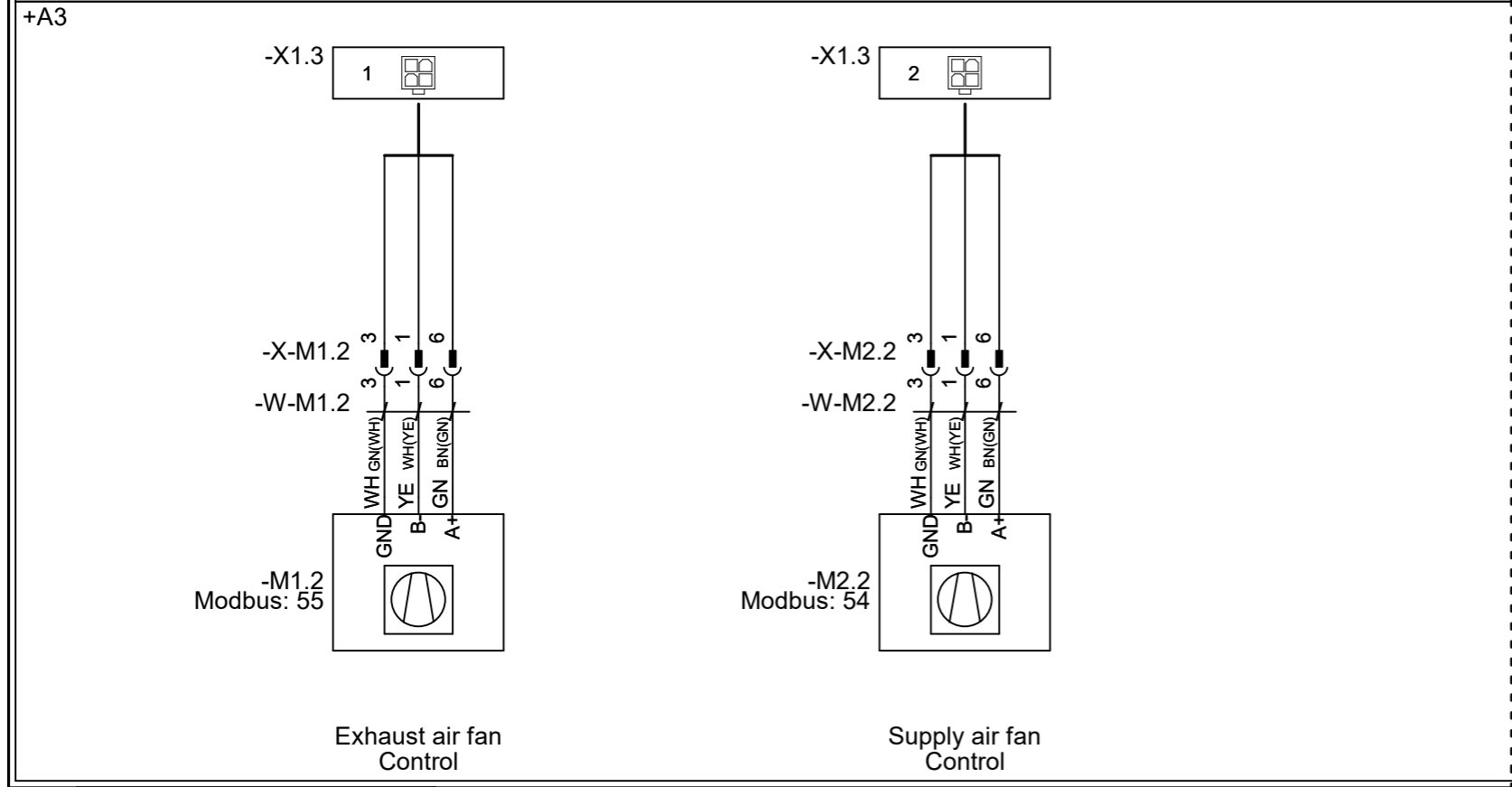

<b>EXHAUSTO</b>	Revision:	Project:	Start date:	04-02-2026	Constructor:	DKTSA	Page:	23
	<b>A</b>	<b>VEX1000 - Danfoss ECL (3x400V)</b>	Revision date:	26-02-2026	Approved by:	DKLEG	Previous page:	22
	Drawing number:	Page Title:	Replaces:	-	Scale:	1:1	Next page:	24
	<b>2029220</b>	<b>Standard - Fan &amp; Rotor/Bypass controls</b>	EC no.:	-	Format:	A3	Pages in total:	32

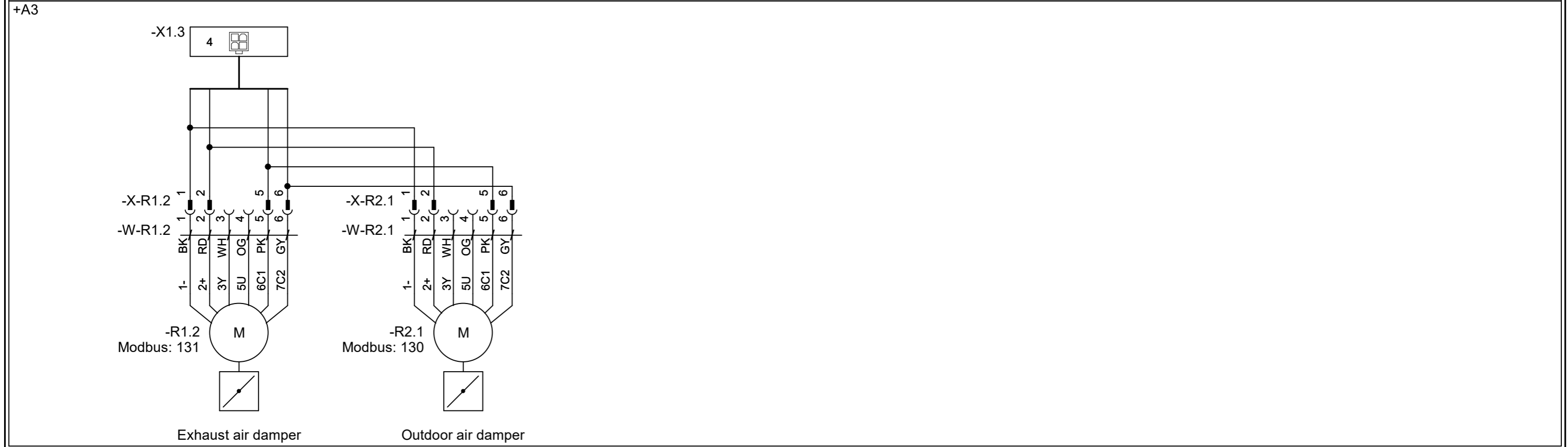
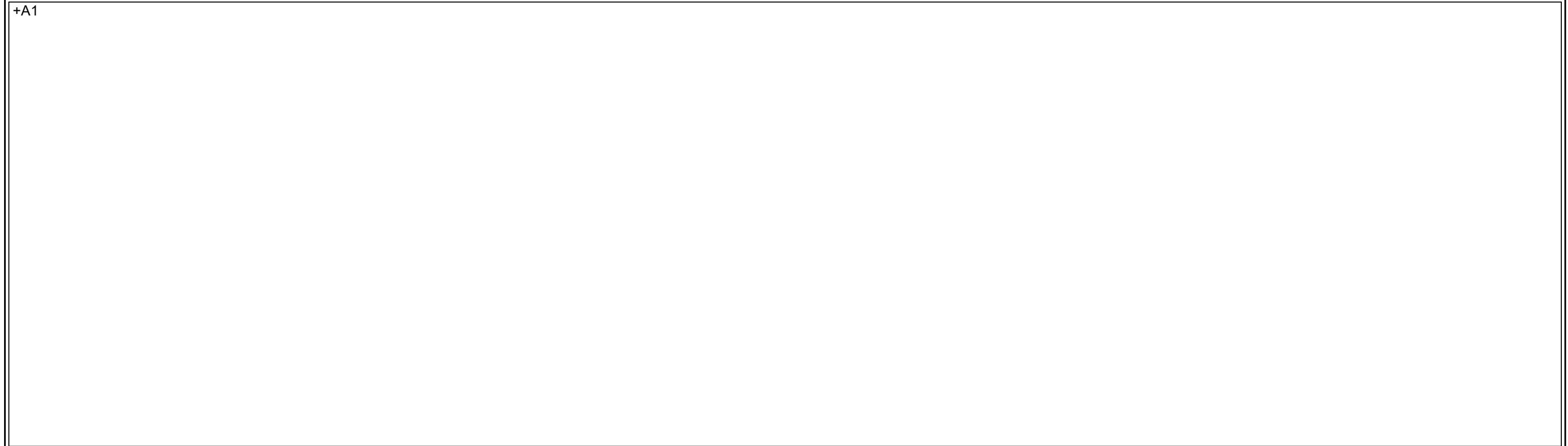

EXHAUSTO	Revision:	Project:	Start date:	04-02-2026	Constructor:	DKTSA	Page:	24
	<b>A</b>	<b>VEX1000 - Danfoss ECL (3x400V)</b>	Revision date:	26-02-2026	Approved by:	DKLEG	Previous page:	23
	Drawing number:	Page Title:	Replaces:	-	Scale:	1:1	Next page:	25
	<b>2029220</b>	<b>Standard - Dampers</b>	EC no.:	-	Format:	A3	Pages in total:	32

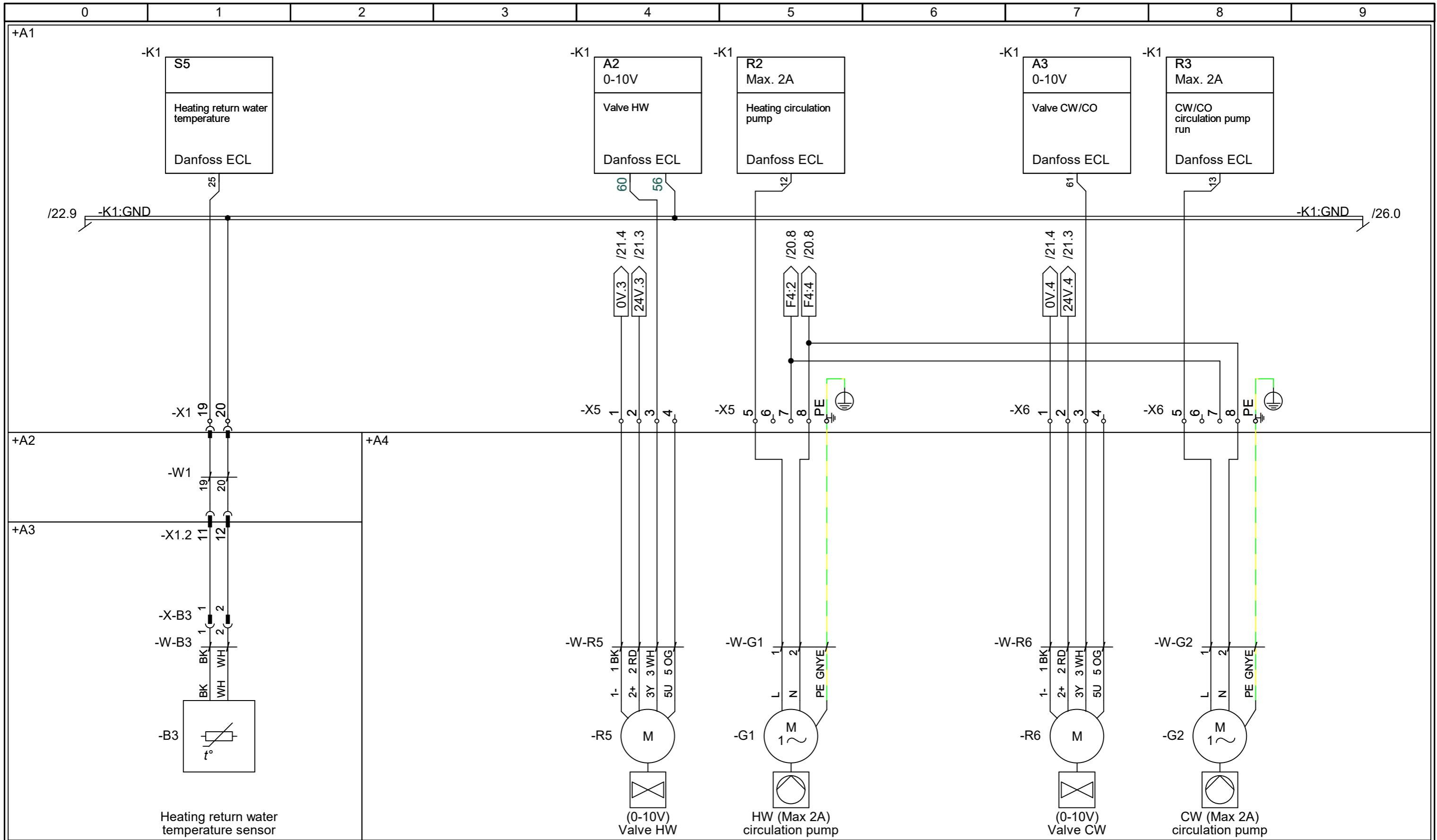

EXHAUSTO	Revision:	Project:	Start date:	04-02-2026	Constructor:	DKTSA	Page:	25
	<b>A</b>	<b>VEX1000 - Danfoss ECL (3x400V)</b>	Revision date:	26-02-2026	Approved by:	DKLEG	Previous page:	24
	Drawing number:	Page Title:	Replaces:	-	Scale:	1:1	Next page:	26
	<b>2029220</b>	<b>Options - HW/CW controls</b>	EC no.:	-	Format:	A3	Pages in total:	32

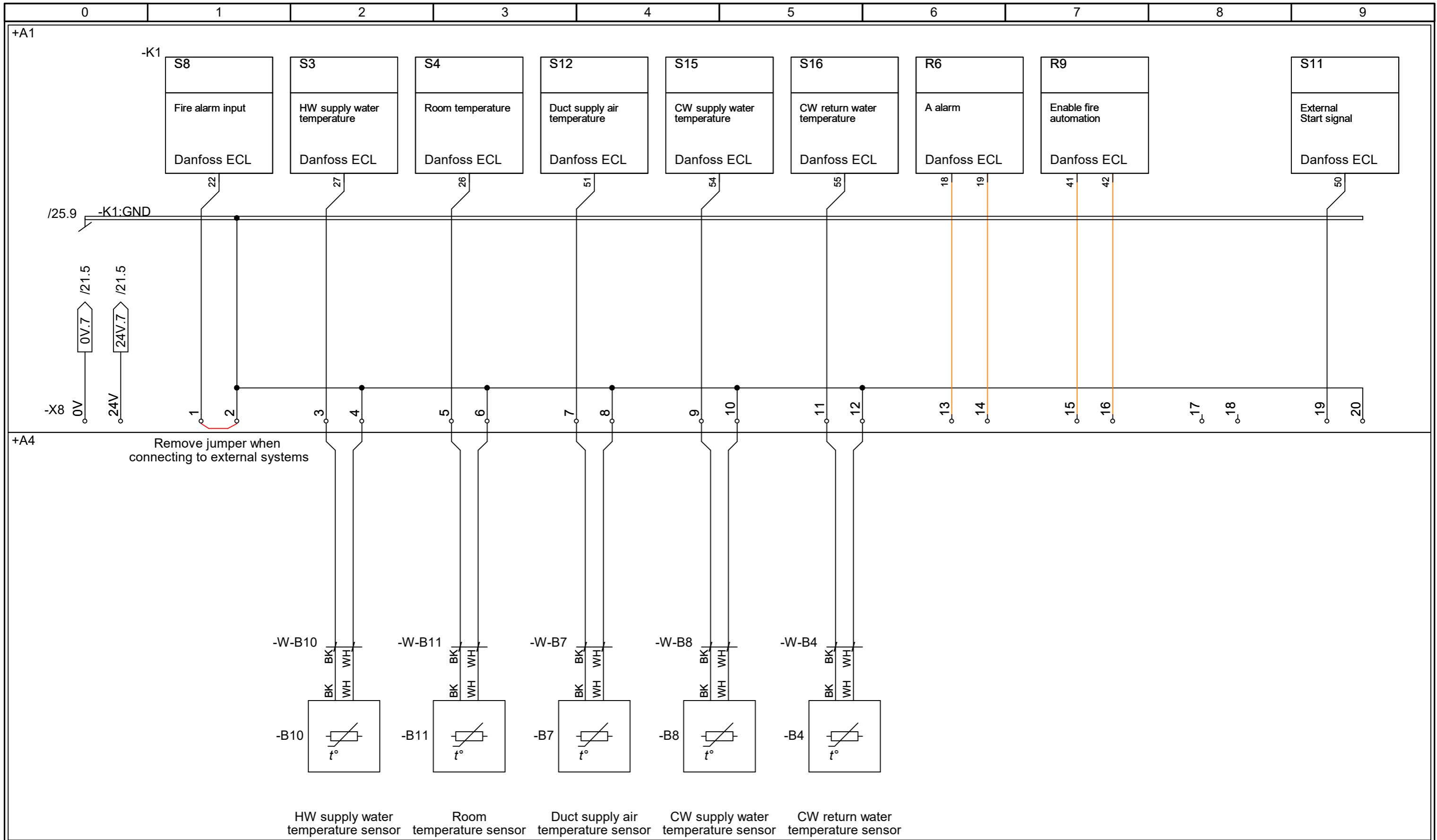

EXHAUSTO	Revision:	Project:	Start date:	04-02-2026	Constructor:	DKTSA	Page:	26
	<b>A</b>	<b>VEX1000 - Danfoss ECL (3x400V)</b>	Revision date:	26-02-2026	Approved by:	DKLEG	Previous page:	25
	Drawing number:	Page Title:	Replaces:	-	Scale:	1:1	Next page:	40
	<b>2029220</b>	<b>Options - Customer connections</b>	EC no.:	-	Format:	A3	Pages in total:	32

# Pressure & temperature transmitters

EXHAUSTO	Revision:	Project:	Start date:	04-02-2026	Constructor:	DKTSA	Page:	PTH
	A	VEX1000 - Danfoss ECL (3x400V)	Revision date:	26-02-2026	Approved by:	DKLEG	Previous page:	26
	Drawing number:	Page Title:	Replaces:	-	Scale:	1:1	Next page:	40
	2029220	Pressure & temperature transmitters	EC no.:	-	Format:	A3	Pages in total:	32

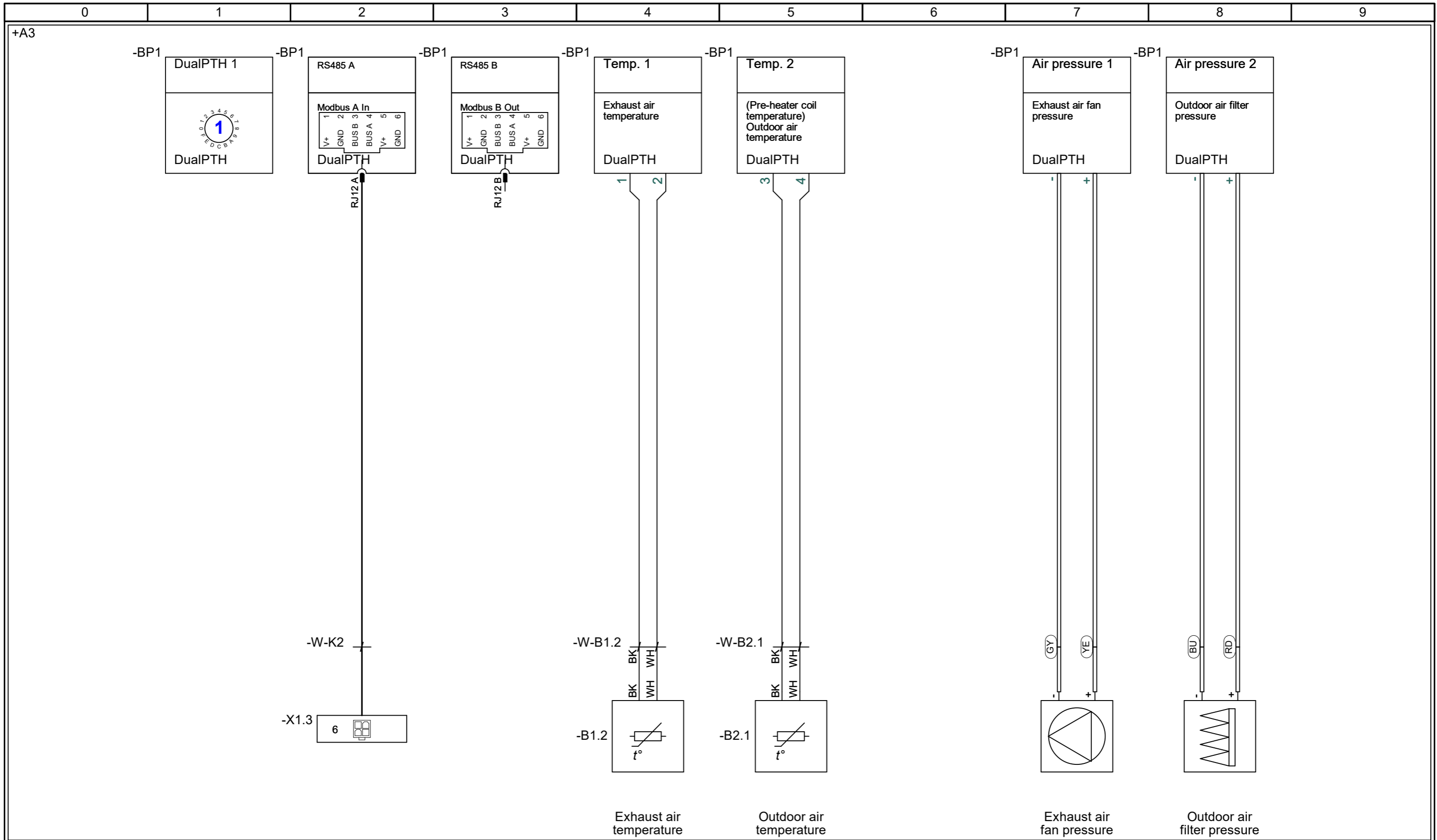

EXHAUSTO	Revision:	Project:	Start date:	04-02-2026	Constructor:	DKTSA	Page:	40
	<b>A</b>	<b>VEX1000 - Danfoss ECL (3x400V)</b>	Revision date:	26-02-2026	Approved by:	DKLEG	Previous page:	26
	Drawing number:	Page Title:	Replaces:	-	Scale:	1:1	Next page:	41
	<b>2029220</b>	<b>Standard - Dual PTH 1</b>	EC no.:	-	Format:	A3	Pages in total:	32

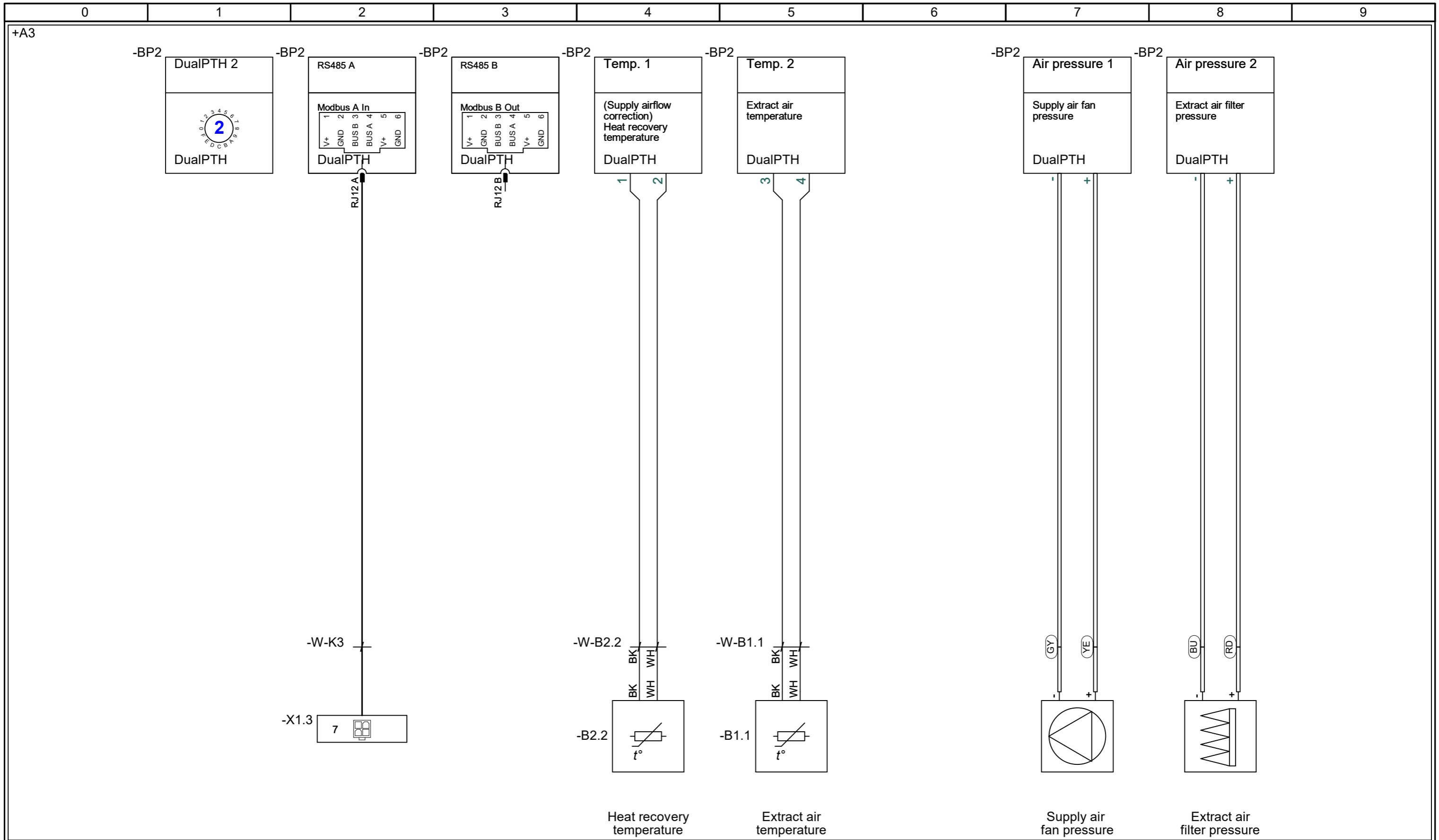

EXHAUSTO	Revision:	Project:	Start date:	04-02-2026	Constructor:	DKTSA	Page:	41
	<b>A</b>	<b>VEX1000 - Danfoss ECL (3x400V)</b>	Revision date:	26-02-2026	Approved by:	DKLEG	Previous page:	40
	Drawing number:	Page Title:	Replaces:	-	Scale:	1:1	Next page:	50
	<b>2029220</b>	<b>Standard - Dual PTH 2</b>	EC no.:	-	Format:	A3	Pages in total:	32

# Accessories for ECL

EXHAUSTO	Revision:	Project:	Start date:	04-02-2026	Constructor:	DKTSA	Page:	Accessories
	<b>A</b>	<b>VEX1000 - Danfoss ECL (3x400V)</b>	Revision date:	26-02-2026	Approved by:	DKLEG	Previous page:	41
	Drawing number:	Page Title:	Replaces:	-	Scale:	1:1	Next page:	50
	<b>2029220</b>	<b>Accessories for ECL</b>	EC no.:	-	Format:	A3	Pages in total:	32

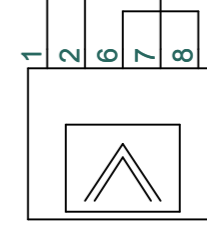
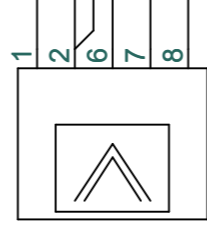
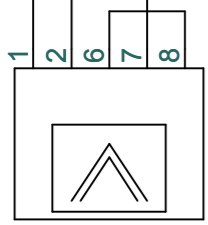
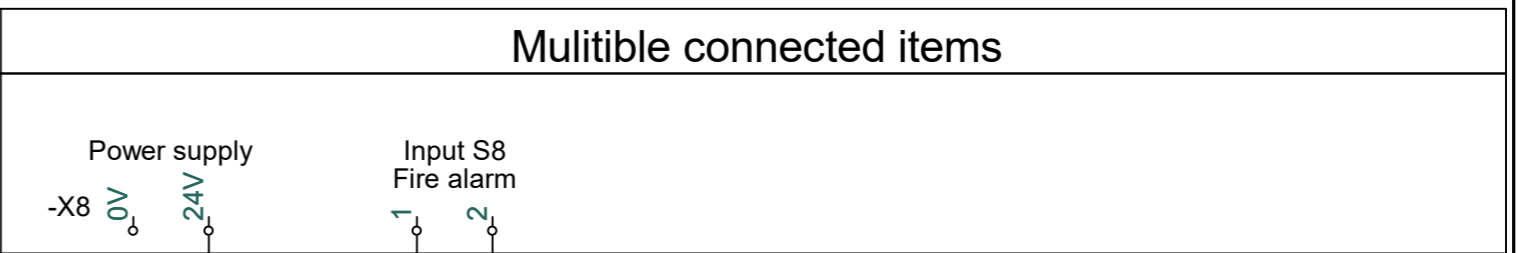
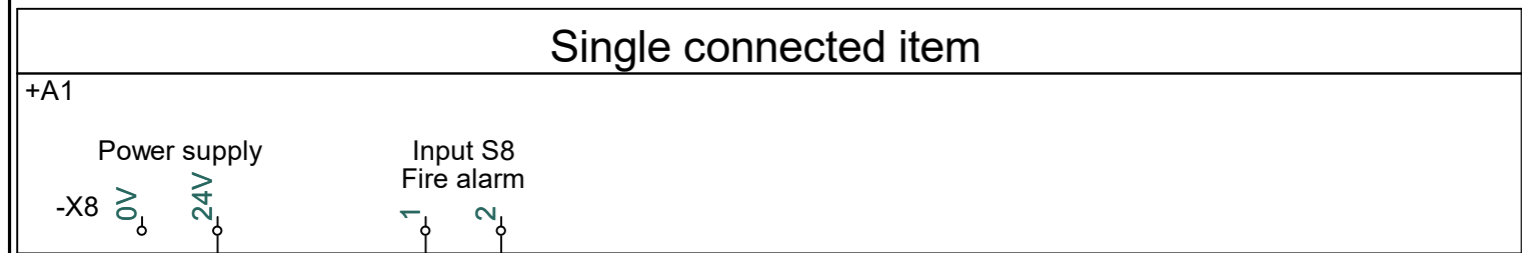

	Terminal	2 +VE In	7 NC	1 -VE in
Standard connection	-X8	:24V	:1	:2

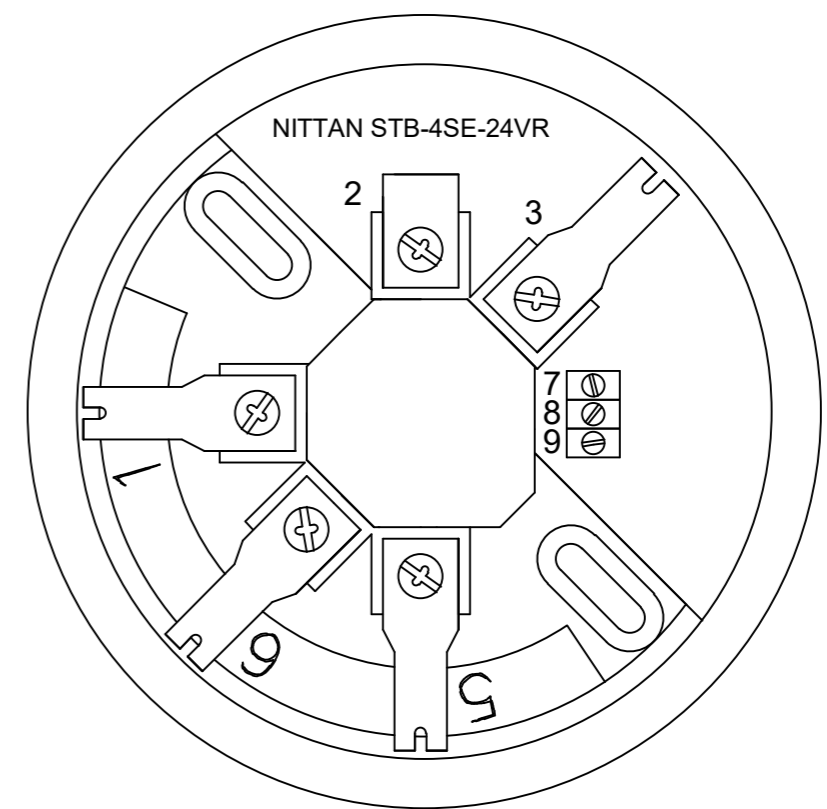

<b>EXHAUSTO</b>	Revision:	<b>A</b>	Project:	<b>VEX1000 - Danfoss ECL (3x400V)</b>	Start date:	04-02-2026	Constructor:	DKTSA	Page:	50
	Drawing number:	<b>2029220</b>	Page Title:	<b>Smoke detector for rooms - SDB</b>	Revision date:	26-02-2026	Approved by:	DKLEG	Previous page:	41
					Replaces:	-	Scale:	1:1	Next page:	51
					EC no.:	-	Format:	A3	Pages in total:	32

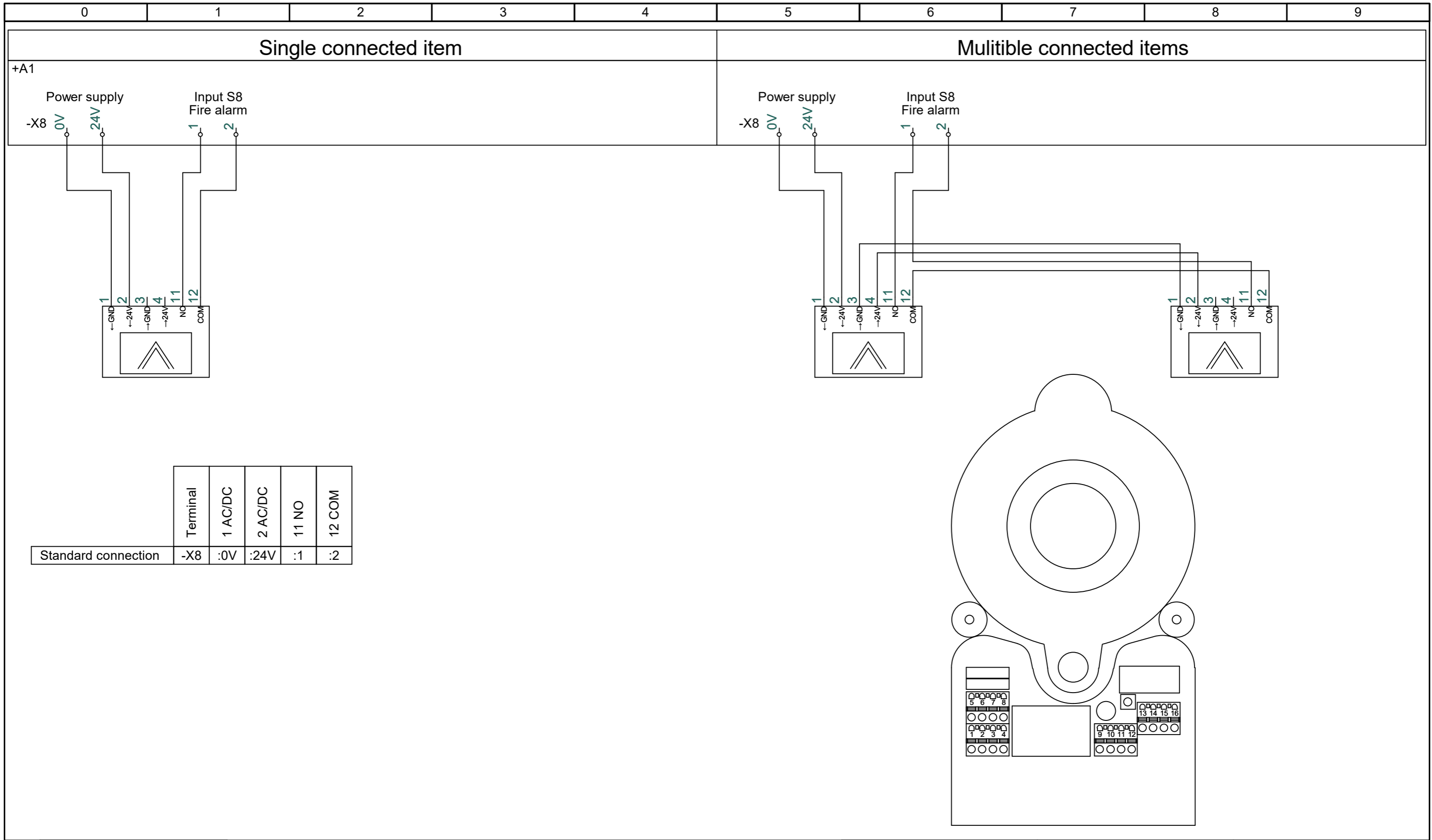

<b>EXHAUSTO</b>	Revision:	<b>A</b>	Project:	<b>VEX1000 - Danfoss ECL (3x400V)</b>	Start date:	04-02-2026	Constructor:	DKTSA	Page:	51
	Drawing number:	<b>2029220</b>	Page Title:	<b>Smoke detector for duct mounting - UG8-E-24</b>	Revision date:	26-02-2026	Approved by:	DKLEG	Previous page:	50
					Replaces:	-	Scale:	1:1	Next page:	52
					EC no.:	-	Format:	A3	Pages in total:	32

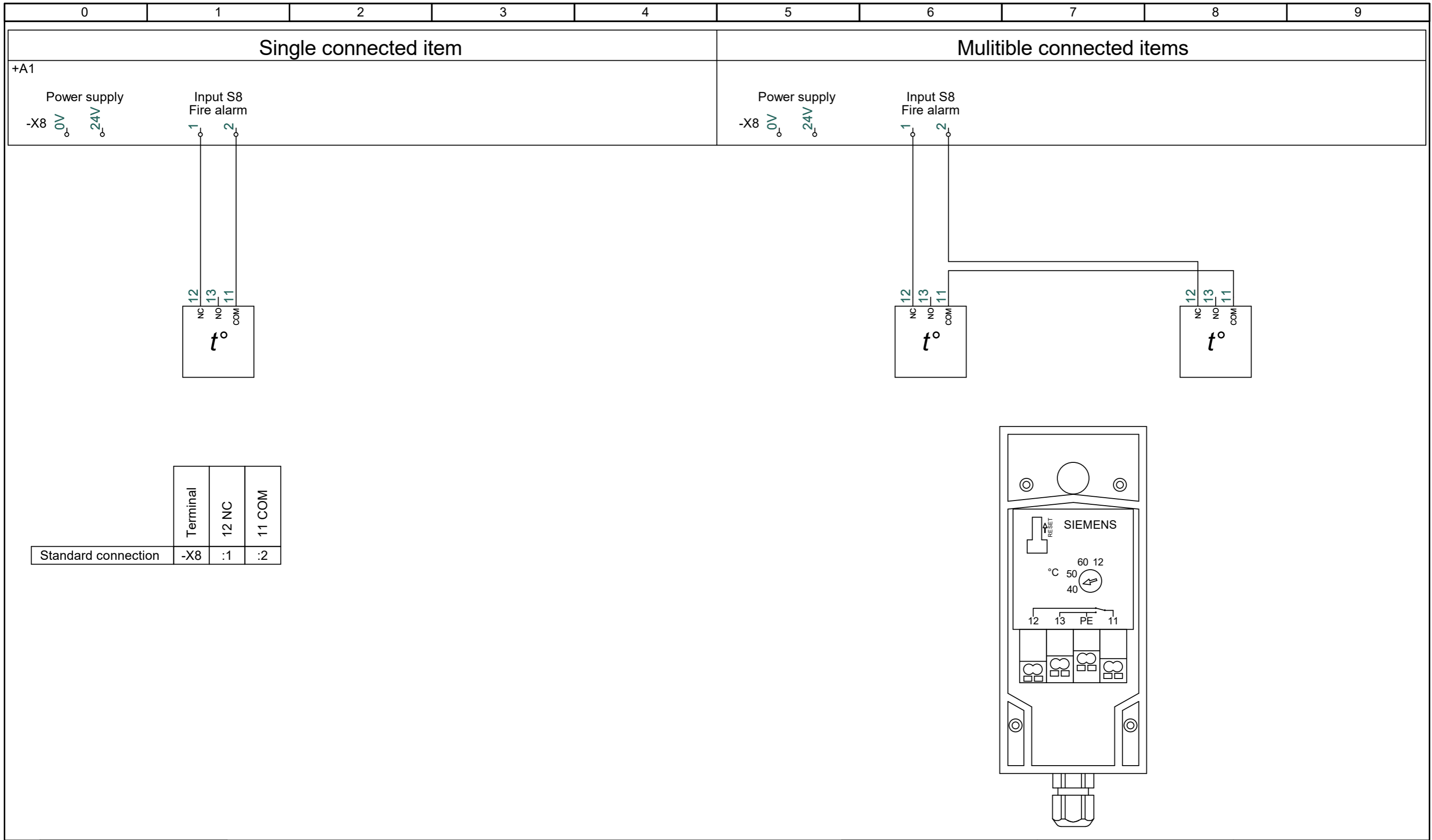

<b>EXHAUSTO</b>	Revision:	Project:	Start date:	04-02-2026	Constructor:	DKTSA	Page:	52
	<b>A</b>	<b>VEX1000 - Danfoss ECL (3x400V)</b>	Revision date:	26-02-2026	Approved by:	DKLEG	Previous page:	51
	Drawing number:	Page Title:	Replaces:	-	Scale:	1:1	Next page:	53
	<b>2029220</b>	<b>Fire thermostat 40-70° - BT40-70</b>	EC no.:	-	Format:	A3	Pages in total:	32

Single connected item	Multible connected items
-----------------------	--------------------------

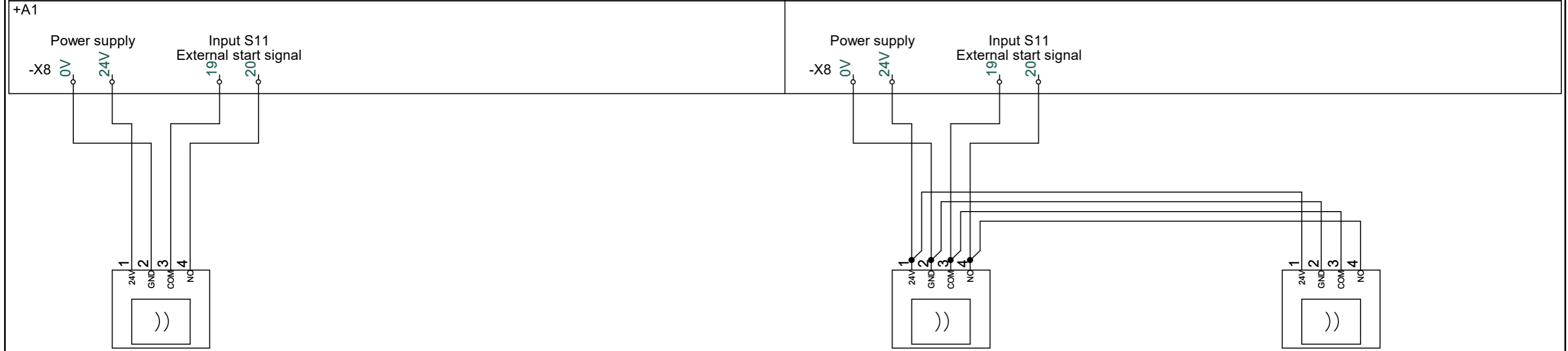

	Terminal	2 GND	1 24V	3 COM	4 NO
Standard connection	-X8	:0V	:24V	:3	:4

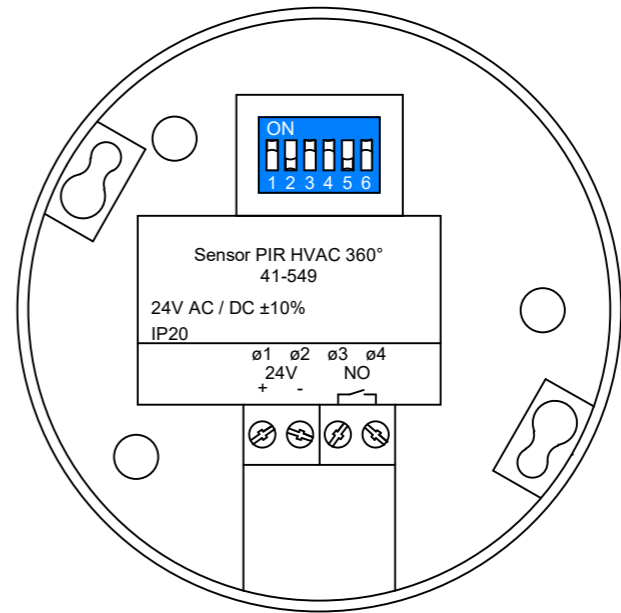

<b>EXHAUSTO</b>	Revision:	<b>A</b>	Project:	<b>VEX1000 - Danfoss ECL (3x400V)</b>	Start date:	04-02-2026	Constructor:	DKTSA	Page:	53
	Drawing number:	<b>2029220</b>	Page Title:	<b>PIR motion detector</b>	Revision date:	26-02-2026	Approved by:	DKLEG	Previous page:	52
					Replaces:	-	Scale:	1:1	Next page:	54
					EC no.:	-	Format:	A3	Pages in total:	32

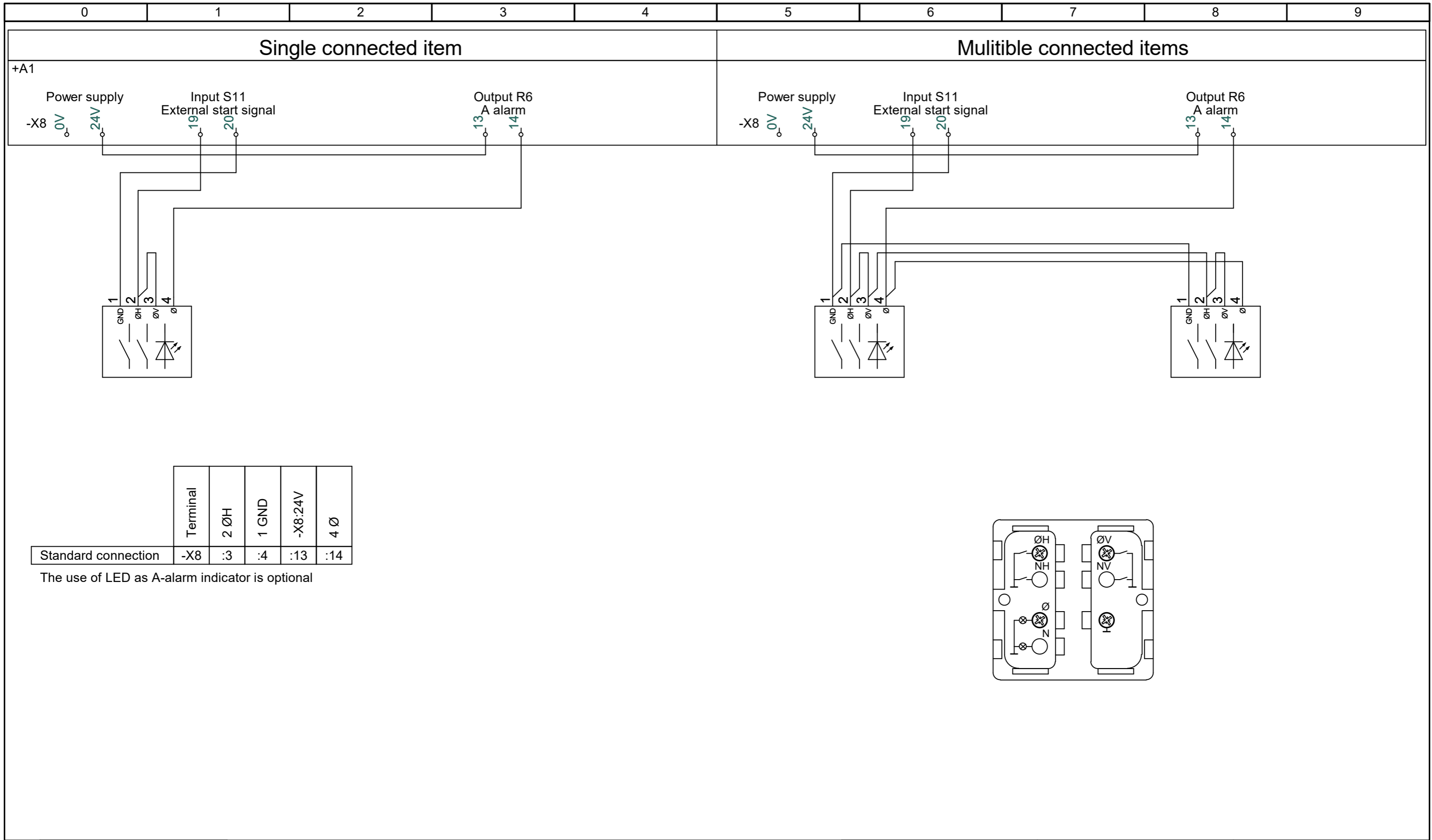

EXHAUSTO	Revision:	Project:	Start date:	04-02-2026	Constructor:	DKTSA	Page:	54
	<b>A</b>	<b>VEX1000 - Danfoss ECL (3x400V)</b>	Revision date:	26-02-2026	Approved by:	DKLEG	Previous page:	53
	Drawing number:	Page Title:	Replaces:	-	Scale:	1:1	Next page:	55
	<b>2029220</b>	<b>Timer button with LED indicator</b>	EC no.:	-	Format:	A3	Pages in total:	32

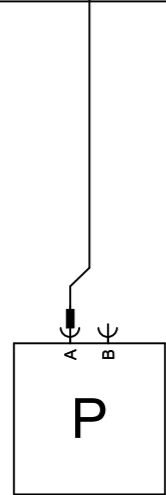
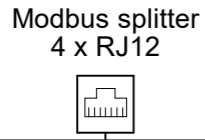
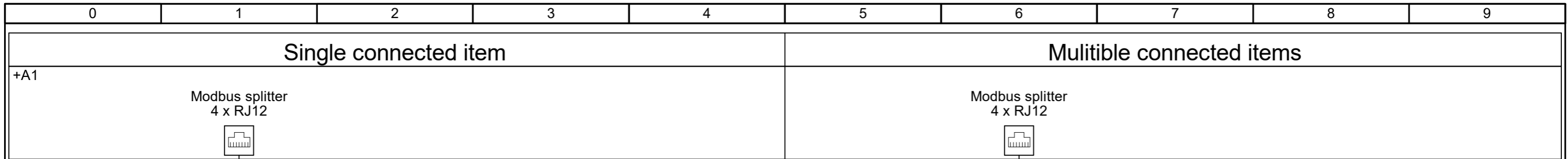

Rotary selector for Supply air: 0  
Rotary selector for Extract air: 1

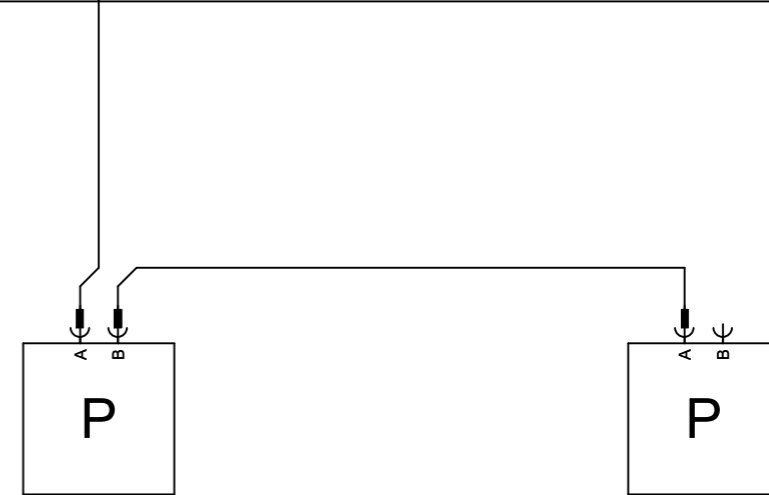
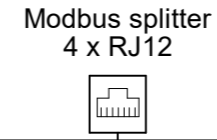

Rotary selector for Supply air: 0  
Rotary selector for Extract air: 1

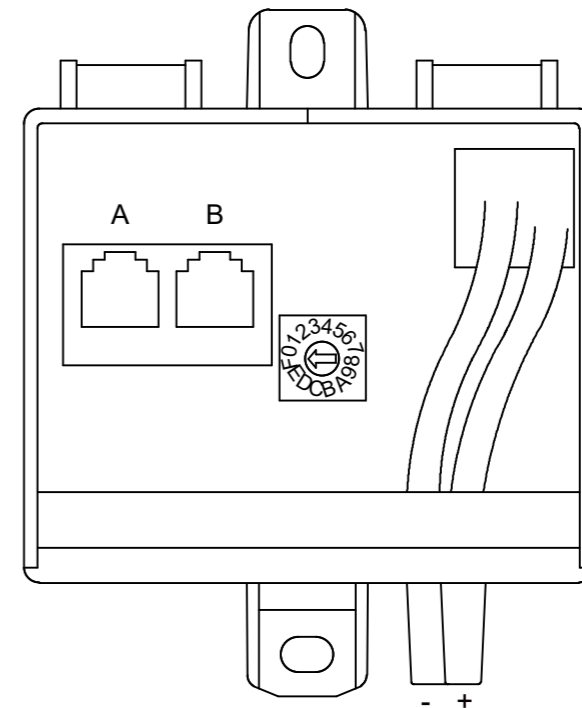

Maximum two PTH4000 can be installed

Kit for Constant Pressure regulation

EXHAUSTO	Revision:	Project:	Start date:	04-02-2026	Constructor:	DKTSA	Page:	55
	A	VEX1000 - Danfoss ECL (3x400V)	Revision date:	26-02-2026	Approved by:	DKLEG	Previous page:	54
	Drawing number:	Page Title:	Replaces:	-	Scale:	1:1	Next page:	.
	2029220	PTH-6202 Constant Pressure regulation kit	EC no.:	-	Format:	A3	Pages in total:	32





Scan code and go to addresses at  
[www.exhausto.dk](http://www.exhausto.dk)

---

**EXHAUSTO**